



Mia Lounge Range

ⓘ The components are heavy, assembly should be performed by two people.

If you have any difficulty with assembly or operation, please contact the store of purchase in the first instance.

Please read the below safety & electrical instructions before operating

Safety Instructions

- This product is not intended for use by persons (including children) with reduced physical, sensory or mental capabilities, or lack of experience and knowledge, unless they have been given supervision or instruction concerning use of the product by a person responsible for their safety.
- Ensure there is no person, animal or item obstructing the area under the footrest before operating this product.
- Improper use or installation may result in the risk of fire, electric shock and/or injury. We assume no liability for any eventual damages caused by improper use or inappropriate handling, or by any other non-compliance with the instructions in this manual.
- Children should be supervised to ensure that they do not play with the product.
- This product contains moving parts. Keep fingers, hair and body parts well clear from moving parts. To reduce the risk of injury, keep children and pets clear of the product when in use.
- Do not sit or place additional weight on the arms, back or open footrest.
- This product is very heavy. Only move this product by lifting the main body. Never drag by the footrest, back or arm rest.
- Return this product to the full upright position to stand safely and prevent a tripping hazard.
- Do not operate this product if damage is visible in any form.
- Do not modify or use unauthorised substitute parts.
- This product has been designed and intended for indoor residential use only. It is not suitable for commercial or outdoor use.
- This product is not intended to be used as part of a health care plan. Consult your medical professional before operating if you are taking medication or have physical limitations.

Electrical Instructions

- Never force the back or footrest to close faster than the electric motor.
- Before commencing cleaning or maintenance, ensure this product is disconnected from the power outlet and the back is in the full upright position.
- Disconnect this product from the power outlet before moving.
- Cease operation and disconnect from the power outlet if you ever detect a burning odour or smoke coming from the product.
- Do not operate this product if liquid spillage occurs on or around it. Disconnect from the power outlet and allow product to completely dry before reconnecting.
- Do not operate the power functions or charge station with wet hands.
- Check the condition of the power cord, electrical cords, transformer, plug and connector on a monthly basis. Do not operate if wear is visible.
- Ensure the power cord, electrical cords and transformer are clear of moving parts and not trapped underneath the base.
- Position the power cord to minimise a tripping hazard.
- Never attempt to open or disassemble electrical components.
- We recommend the use of a surge protector (not included).

Synargy is a registered responsible supplier on ERAC. Electrical components within our products have been tested to comply with legal requirements imposed for electrical safety and EMC.

Step 1

Assemble this product in an open space with room to move. Remove the packaging from the product. The seat backs for the end seats are packaged individually. Keep note of which seat back goes with which base piece. Set aside the power supply and cables in a safe location for Step 7.

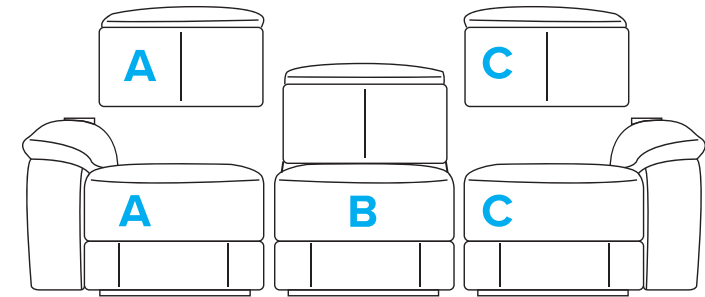

Step 2

Locate the wings and armrest pads, and follow the steps below to attach them to the lounge suite:

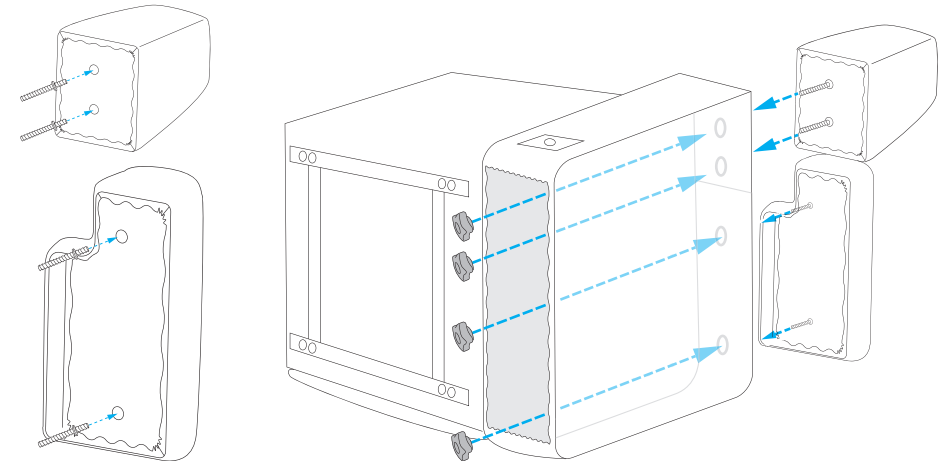

1. Screw the short ends of the bolts into the holes in the underside of the wings and armrest pads.

2. Gently turn the seat base onto its front side and unzip the fabric panel under the armrest. Insert the long end of the bolts on the wings and armrest pads into the corresponding holes in the armrest and reach up into the armrest from the zipped panel to connect the star-shaped nuts. Tighten until firmly secured.

Step 3

Chaise piece only. 2 seater and recliner chair can skip this step.

The feet for the chaise piece are located in a zippered pocket underneath. Retrieve them and attach the feet to the suite per diagram:

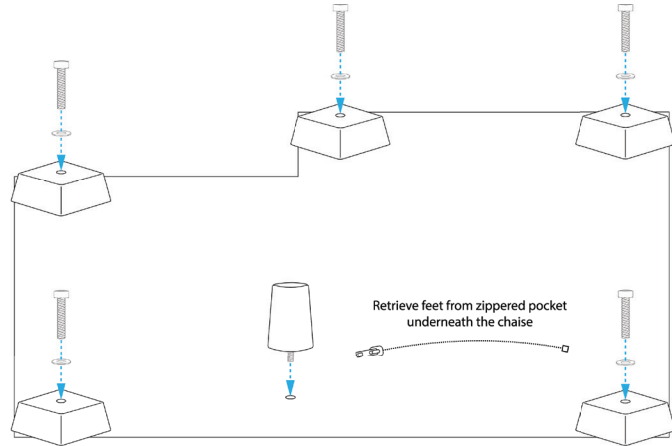

Step 4

Middle seat of 2+Chaise lounge only. 2 Seater and recliner chair can skip this step. The feet for the middle seat are located in a zippered pocket underneath. Retrieve them and attach the feet to the suite per diagram:

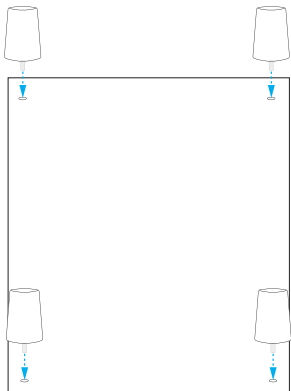

Step 5

Connect the individual base pieces together using the connectors down the side of each seat

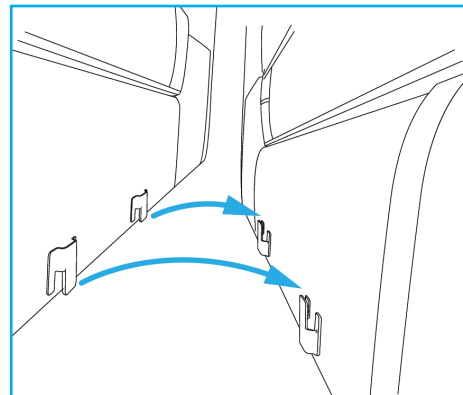

Scan QR code for a video of this step

Step 6

Attach the seat backs (A) and connect the cables between each seat back and base (B). Velcro the flap on the seat back to the base (C). Scan the QR code to view a video of this step.

A.

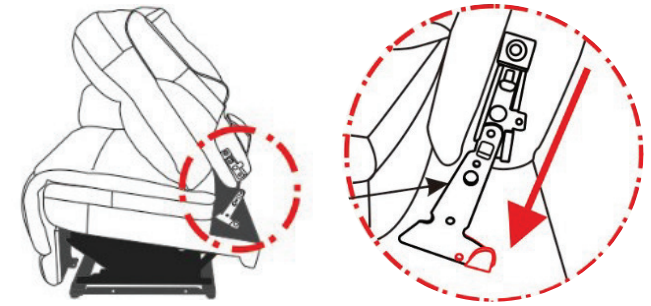

B.

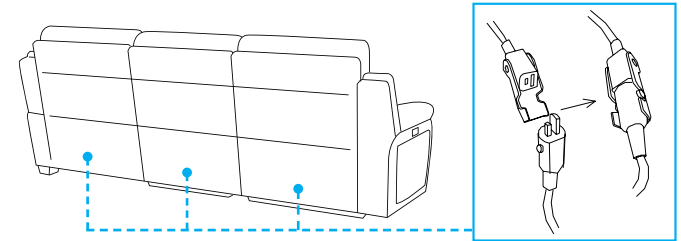

C.

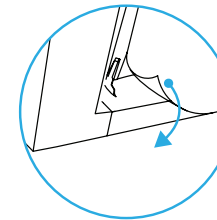

Step 7

Connect the power supply to the back corner of the suite and plug into a wall outlet.